

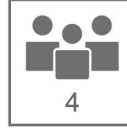



















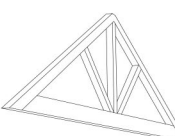
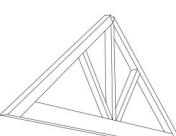
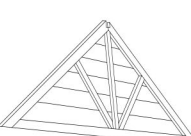



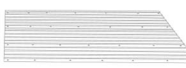
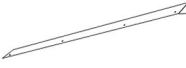





LOBERON

COMING HOME



Ax1 	A1x1 	Bx1 	B1x1 	B2x1 	B3x1 	Cx1 
C1x1 	C2x1 	C3x1 	Dx2 	Ex1 	E1x1 	E2x1 
Fx2 	Gx1 	G1x1 	G2x1 	G3x1 	Hx2 	I1x2 
I2x4 	Jx16  φ4x70mm	Kx12  φ4x90mm	Lx9 	L1x16 	Mx8 	
Nx10 	Ox178  φ3.5x25mm	Px24  φ3.5x50mm	Qx10  φ6x80mm	Rx24  φ 4mm φ 12mm	Sx24  φ3x25mm	



LOBERON

COMING HOME

1

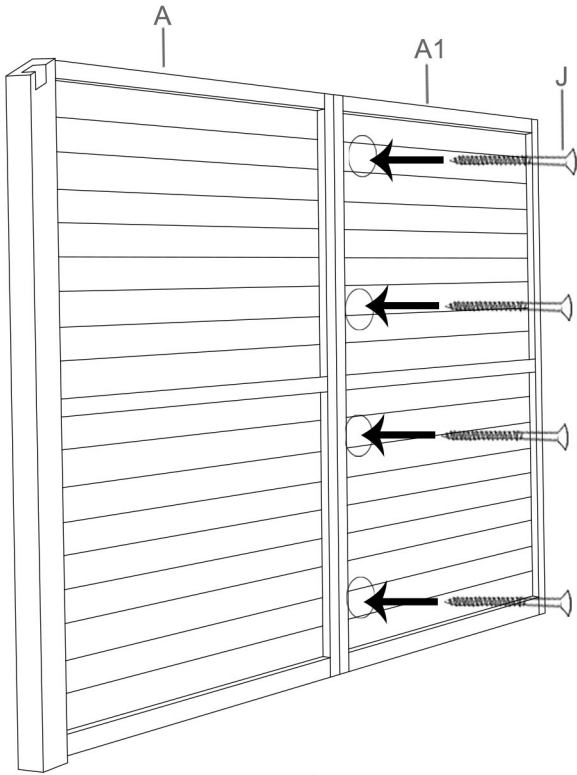

2

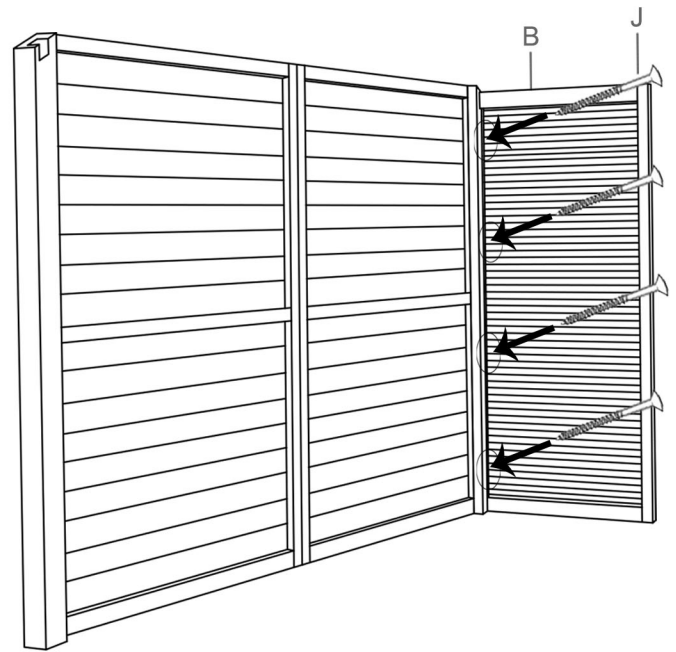

3

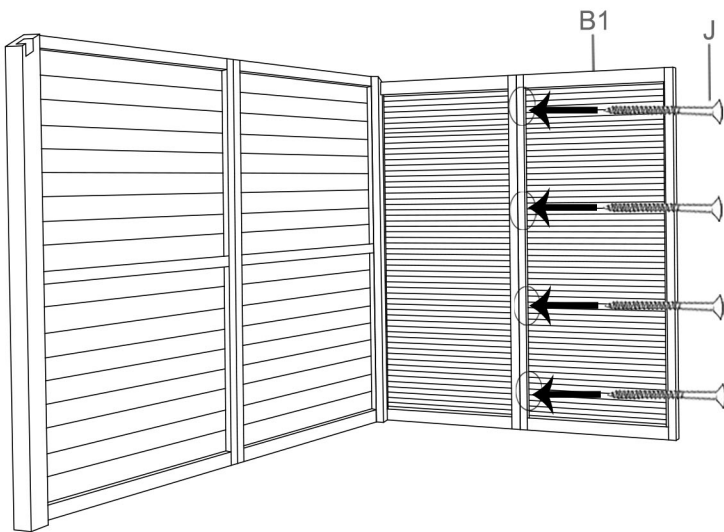

4

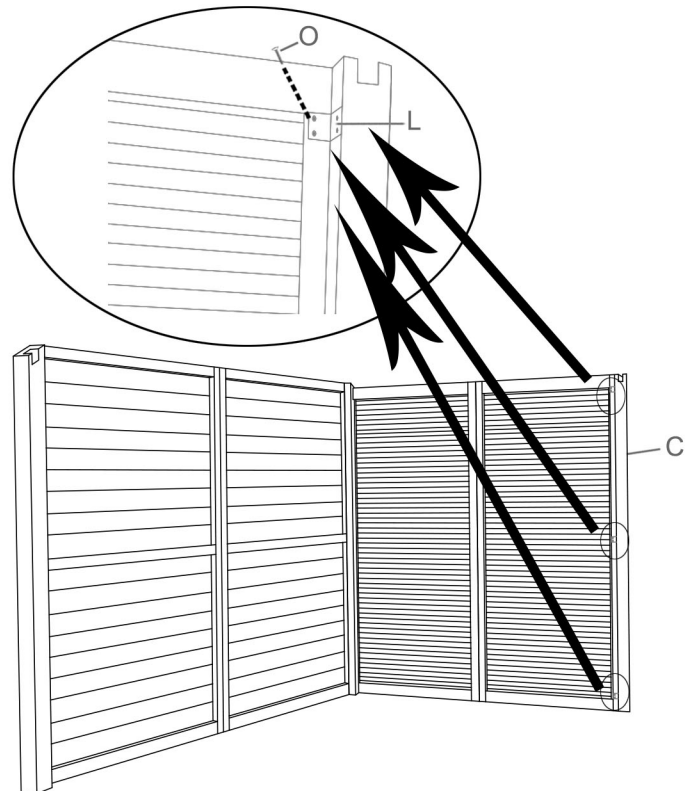

LOBERON

COMING HOME

5

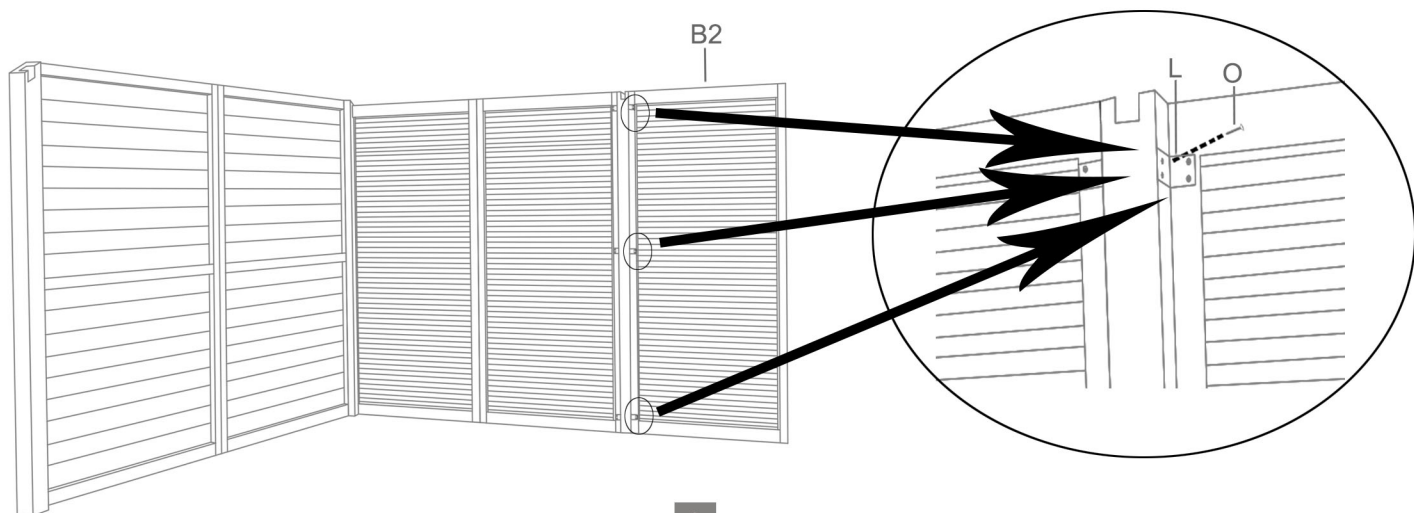

6

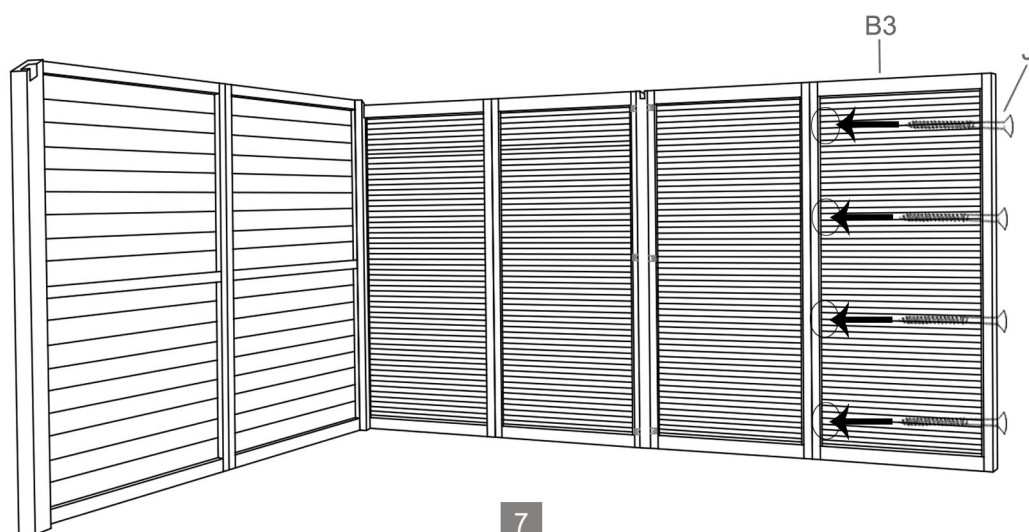

7

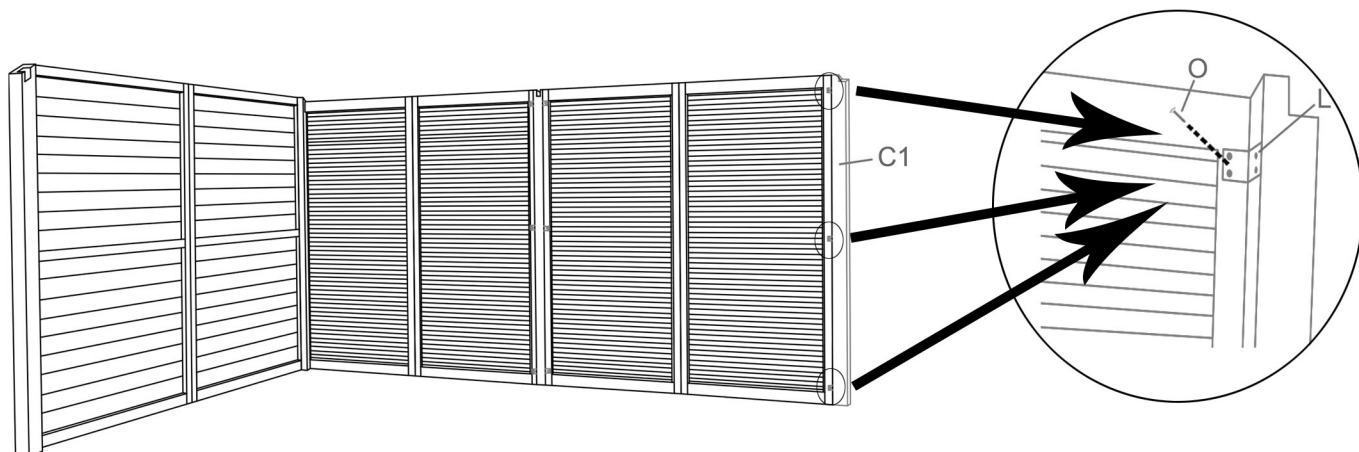

LOBERON

COMING HOME

8

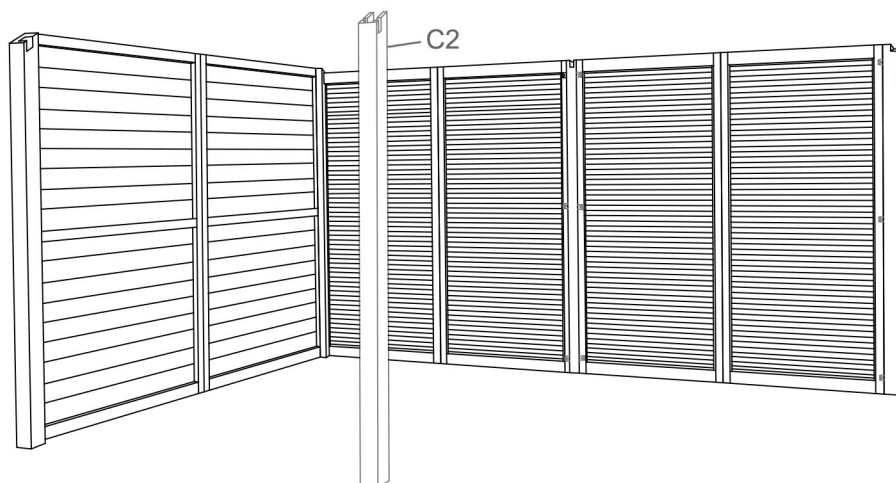

9

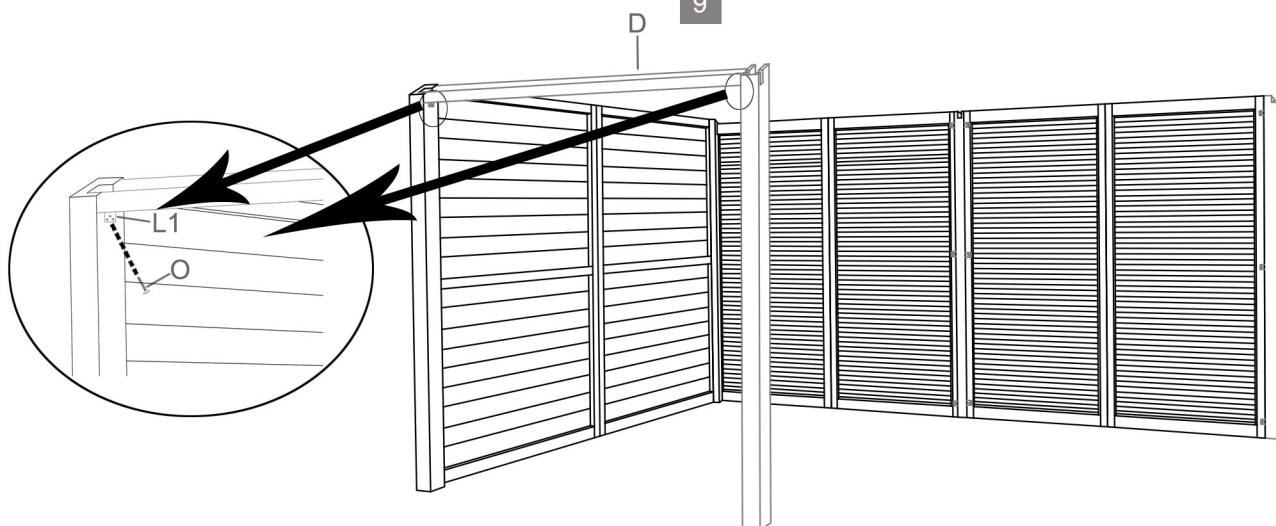

10

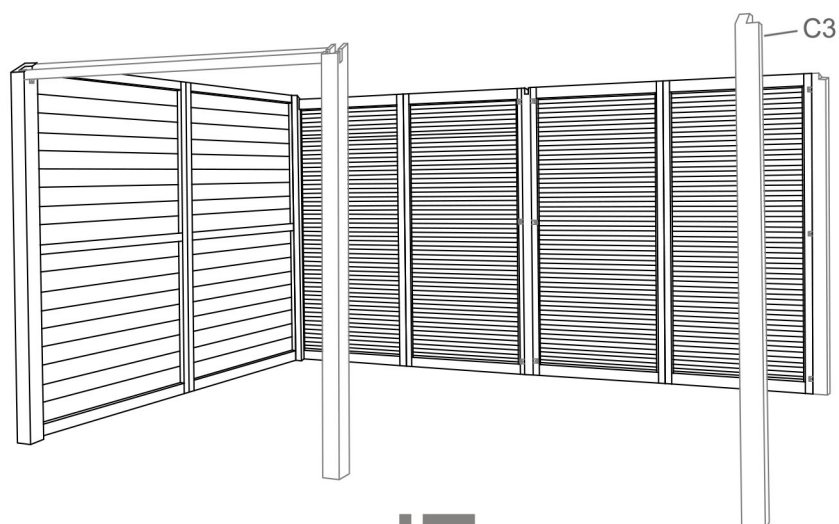

LOBERON

COMING HOME

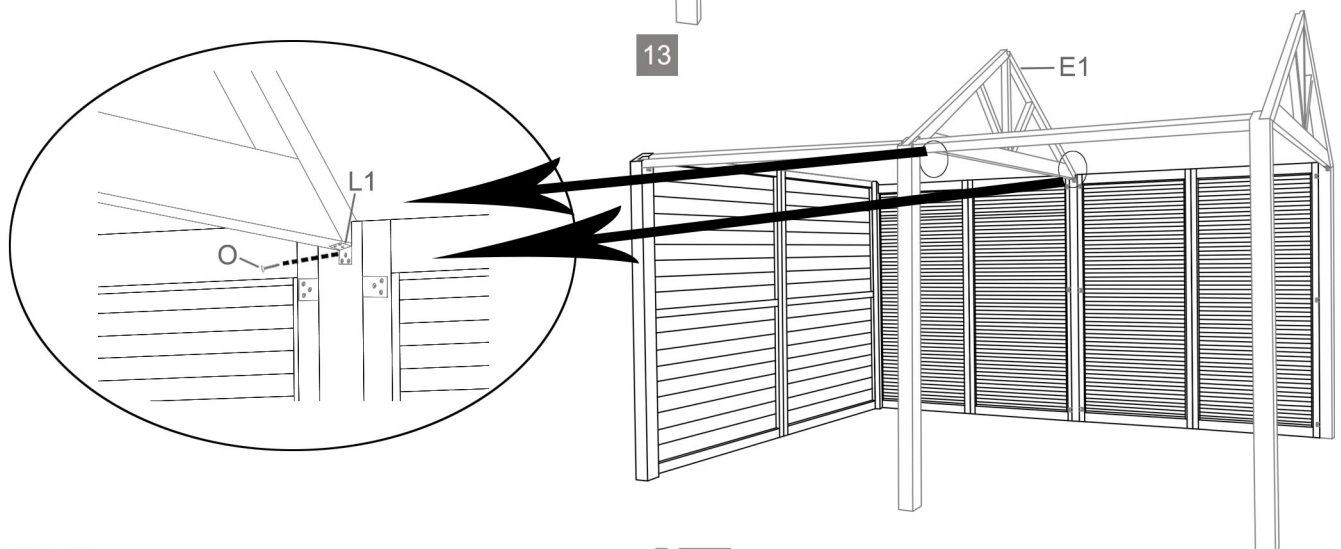
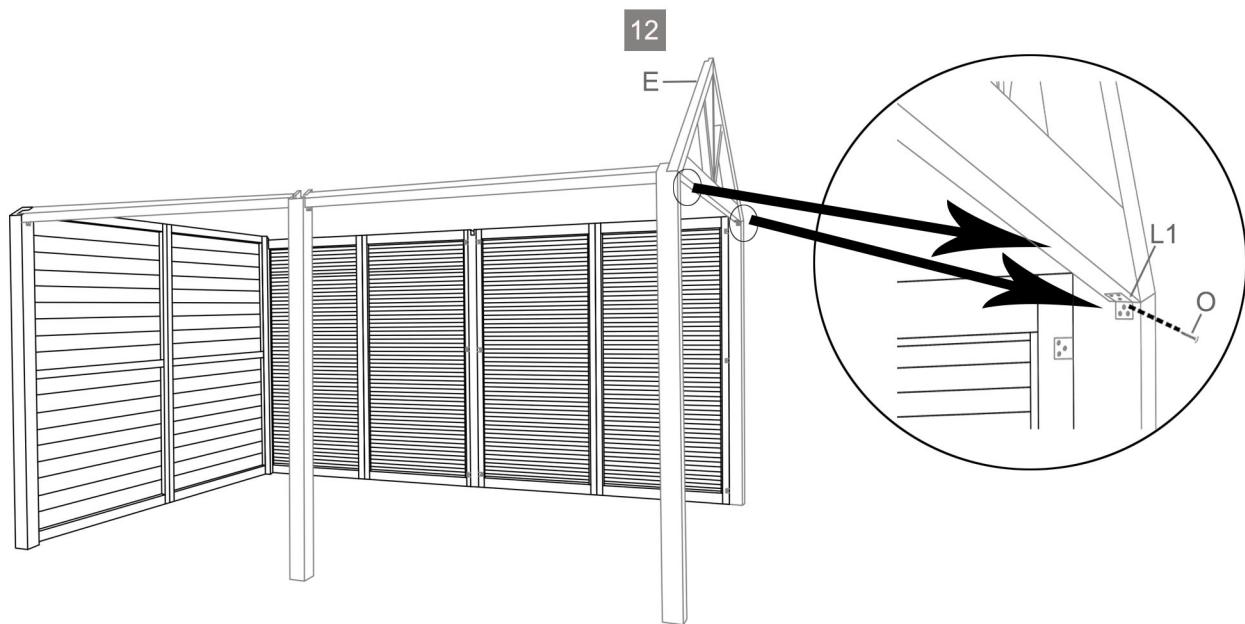
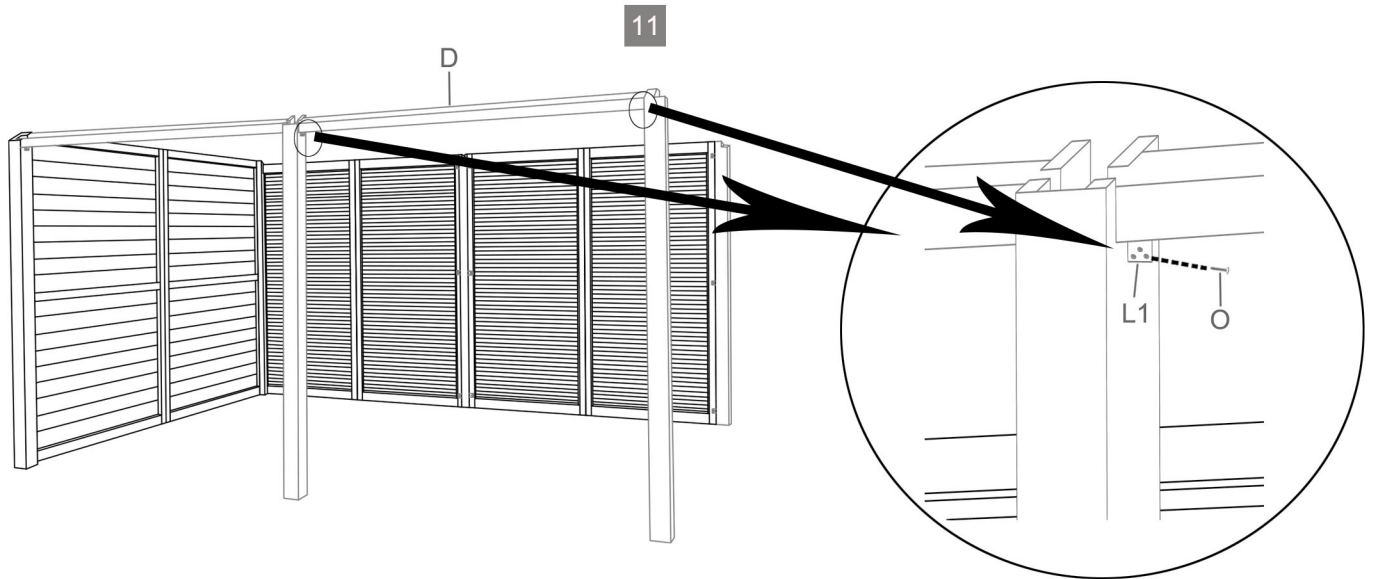

LOBERON

COMING HOME

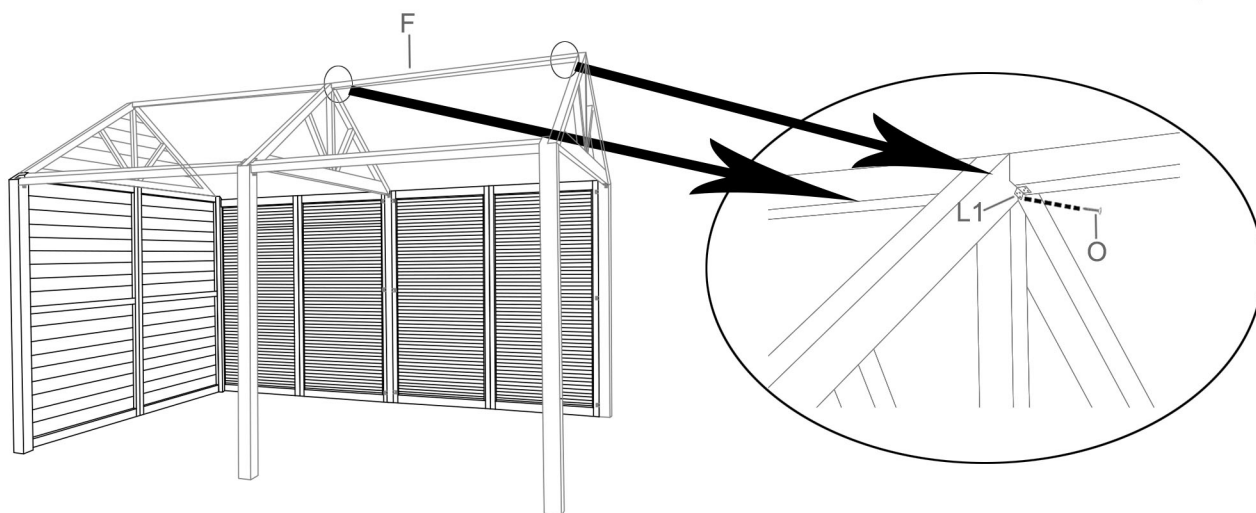
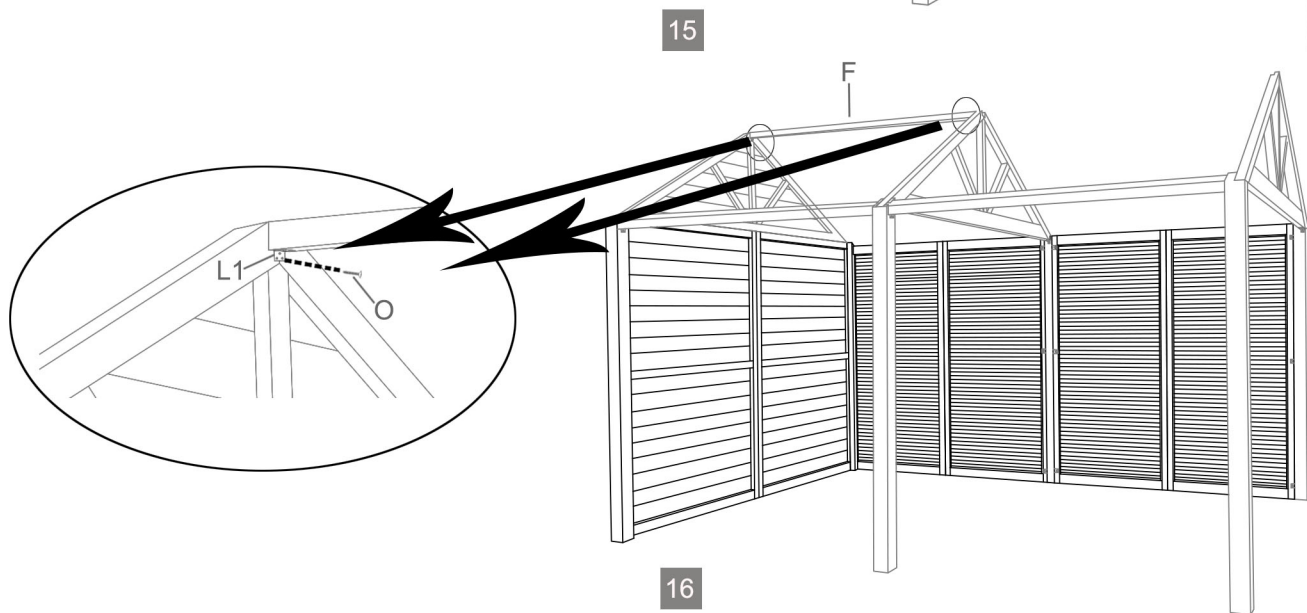
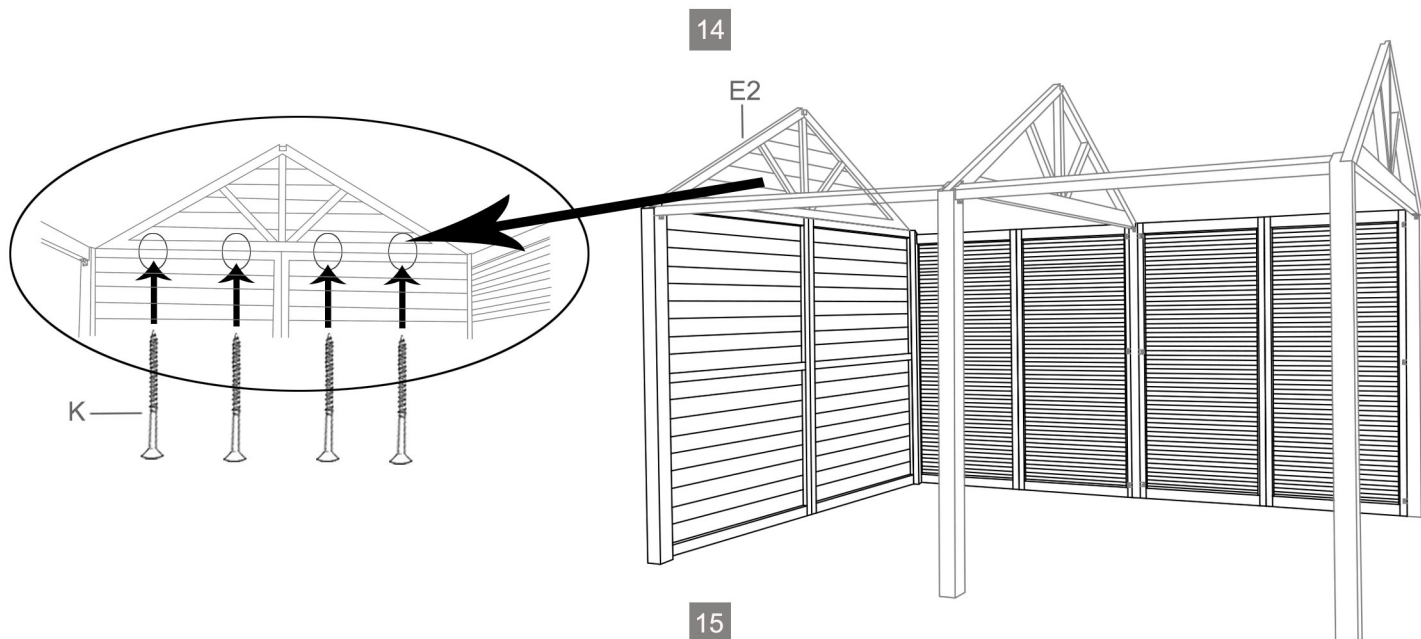

LOBERON

COMING HOME

17

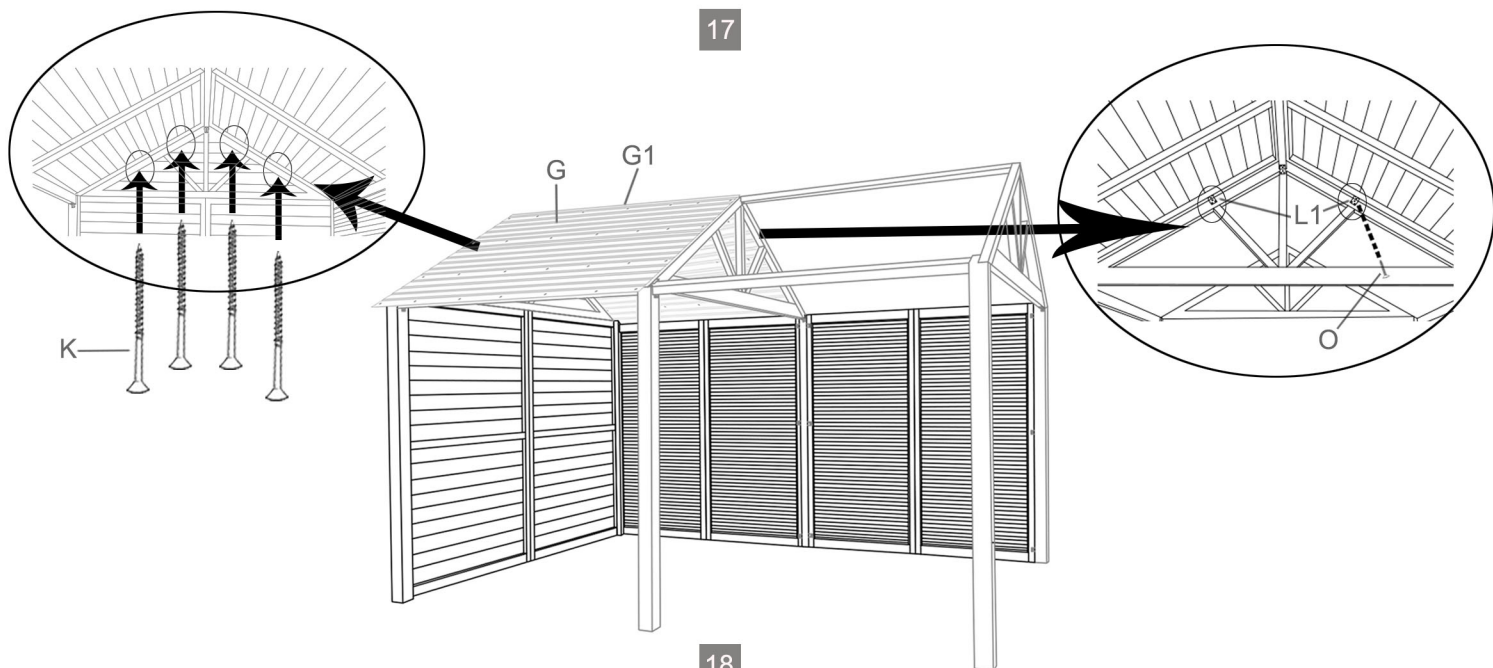

18

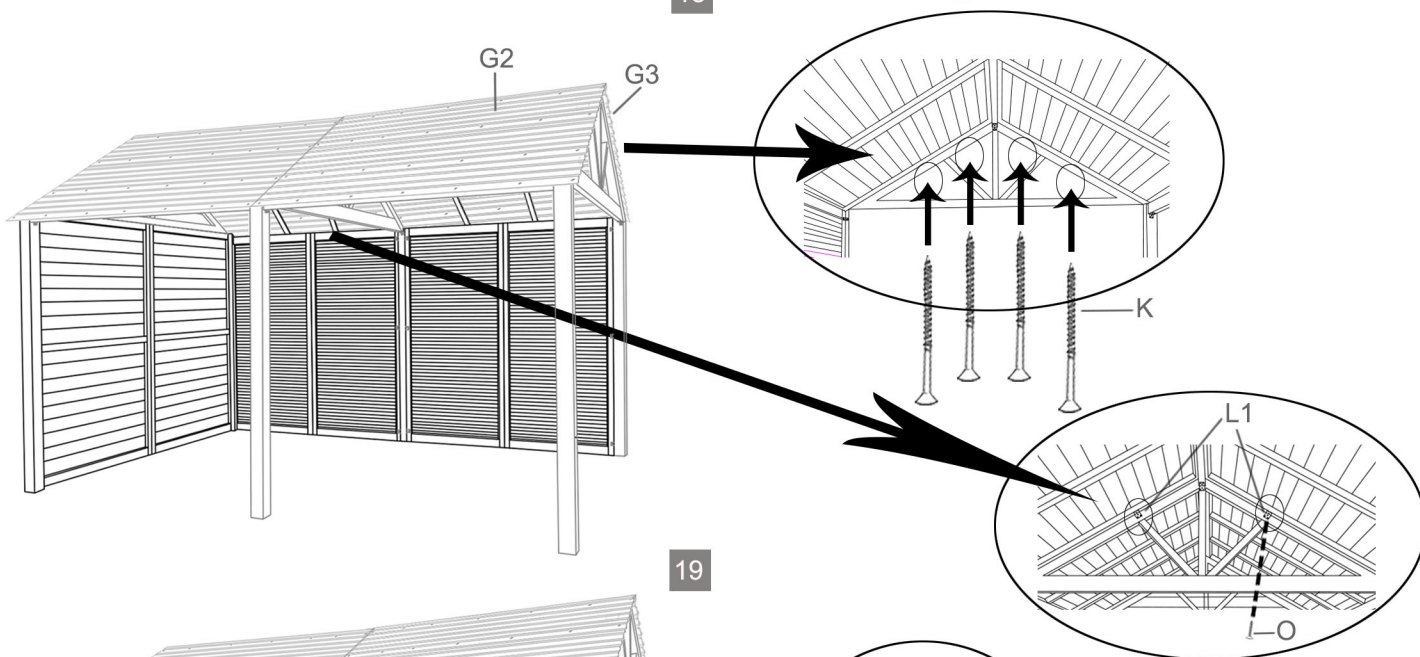

19

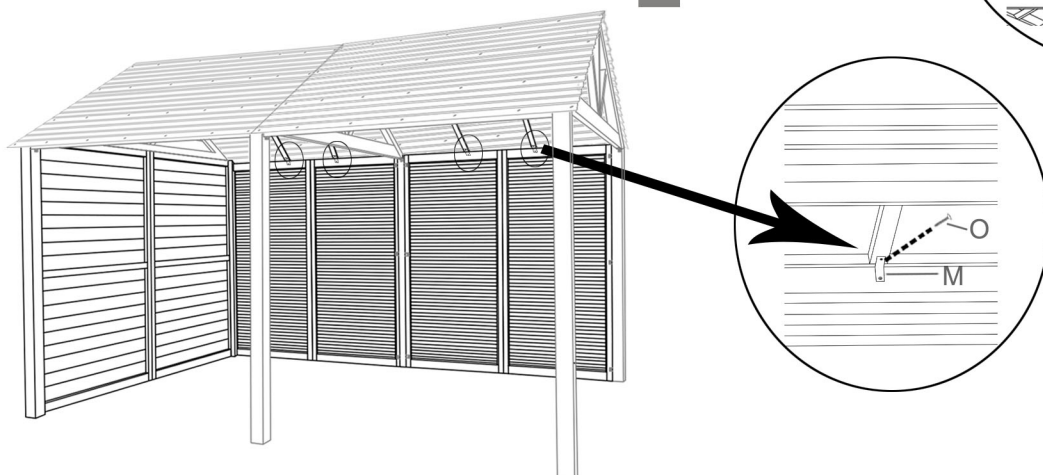

LOBERON

COMING HOME

20

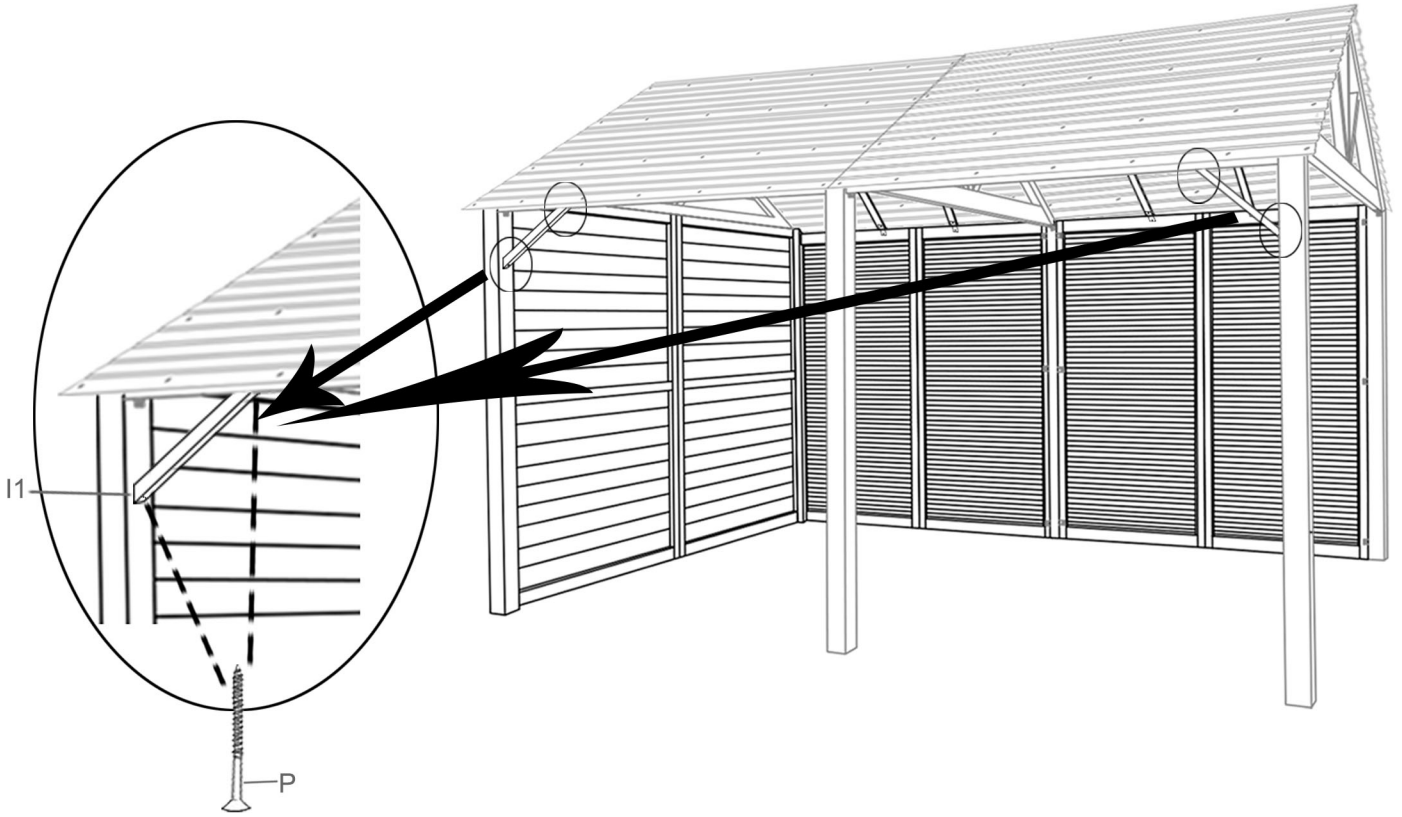

21

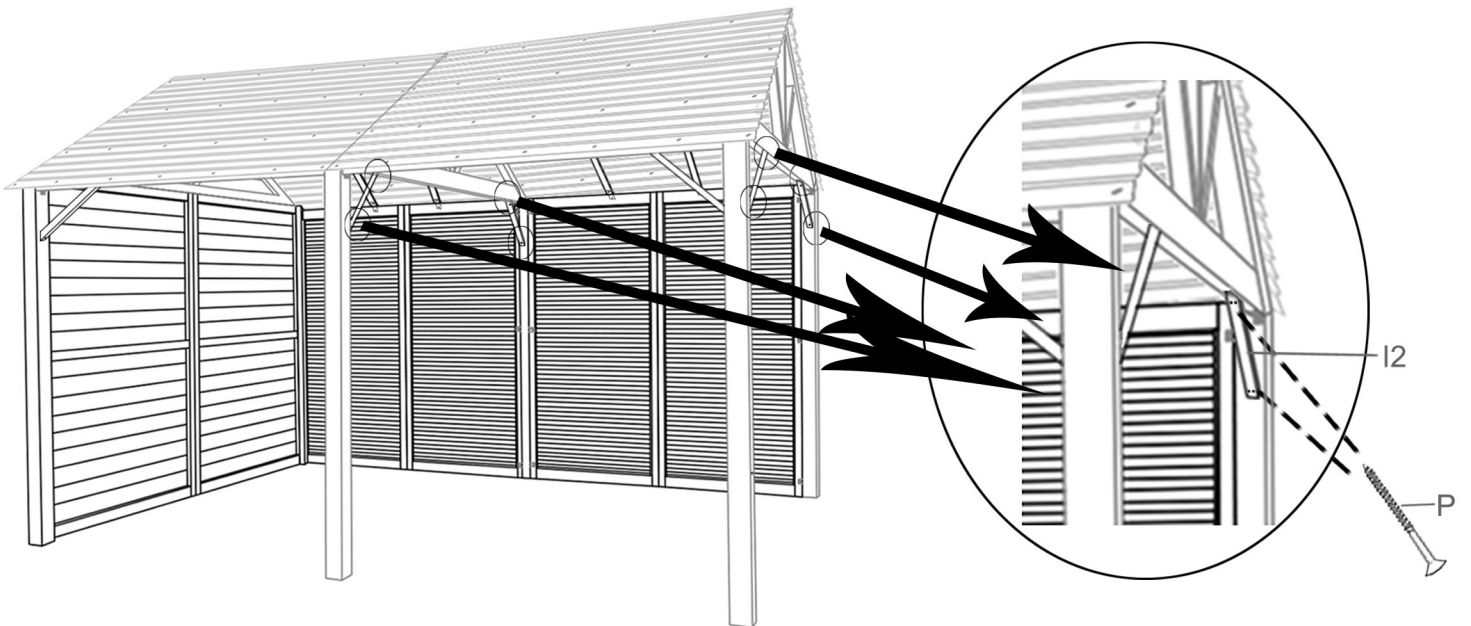

LOBERON

COMING HOME

22

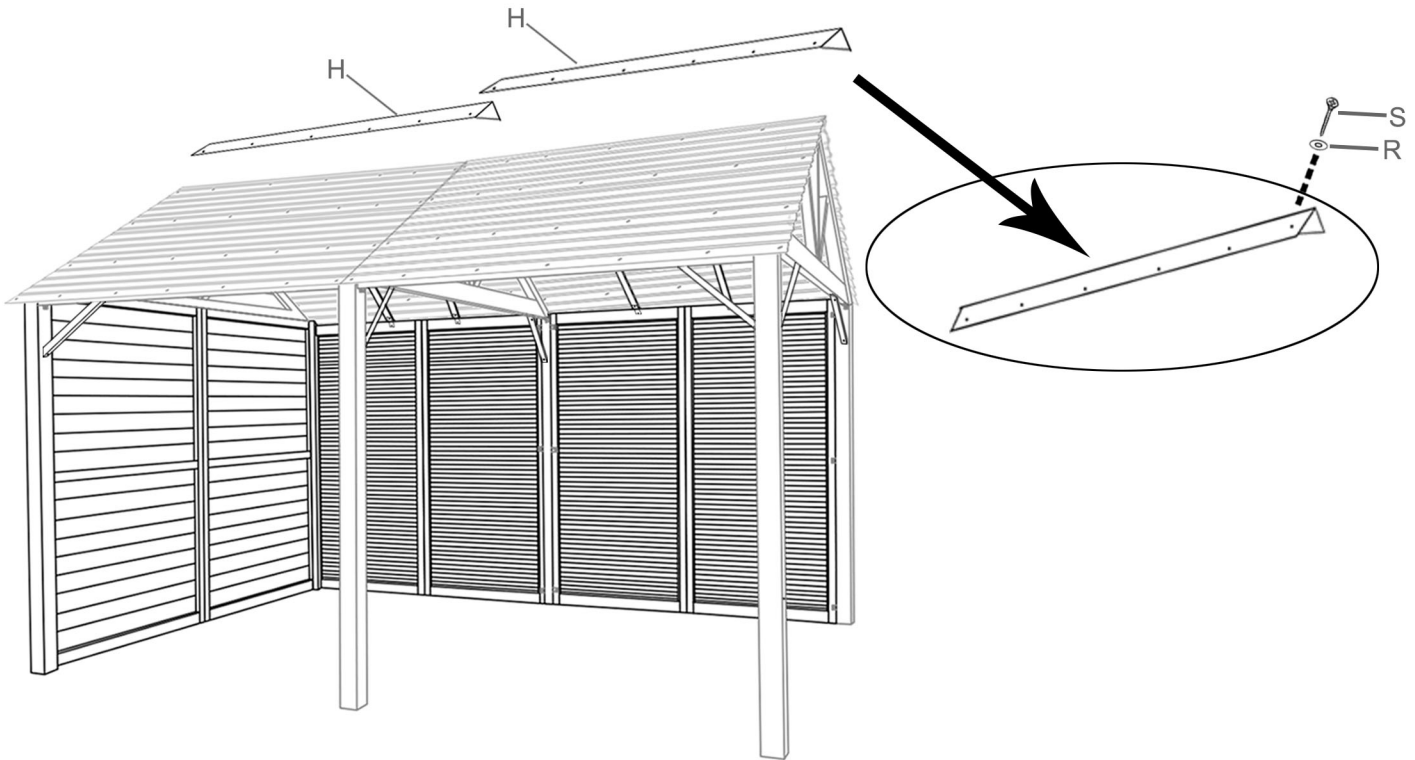

23

