

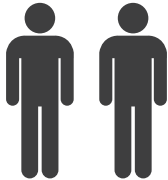

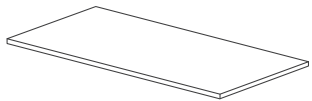

Aufbauanleitung / Assembly instruction /
Montagehandleiding / Plan de montage / Istruzioni di montaggio

19516

 20 min	
--	--

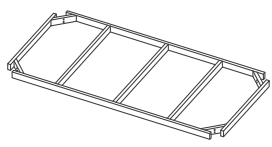
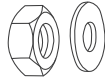
A x 1 	B x 4 	C x 1 	D x 8 
---	--	---	--

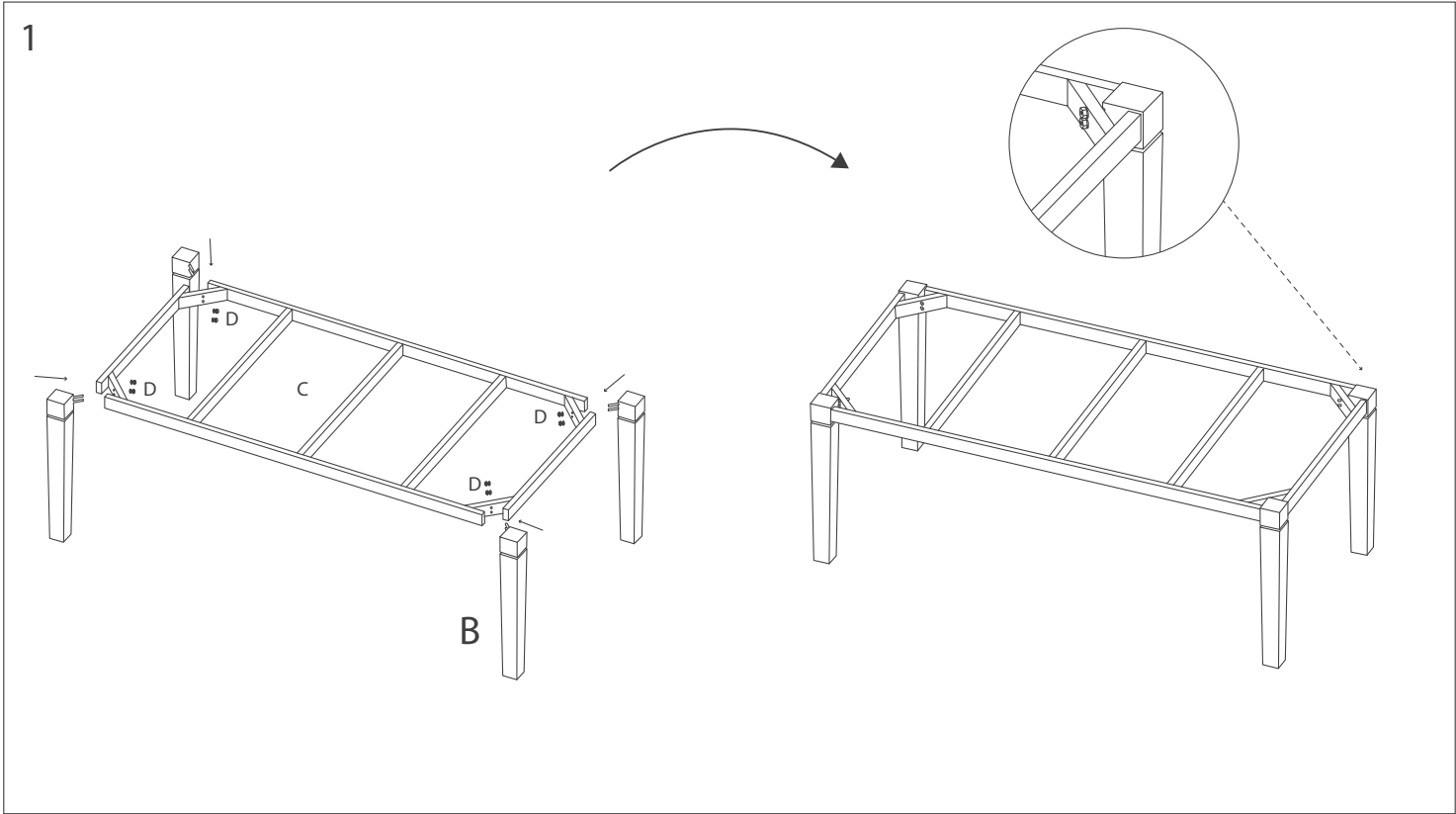

2

